

Model Numbers:
 TRT08-A-01-000 - Advantage Coating
 TRT08-C-01-000 - Industry Standard Coating

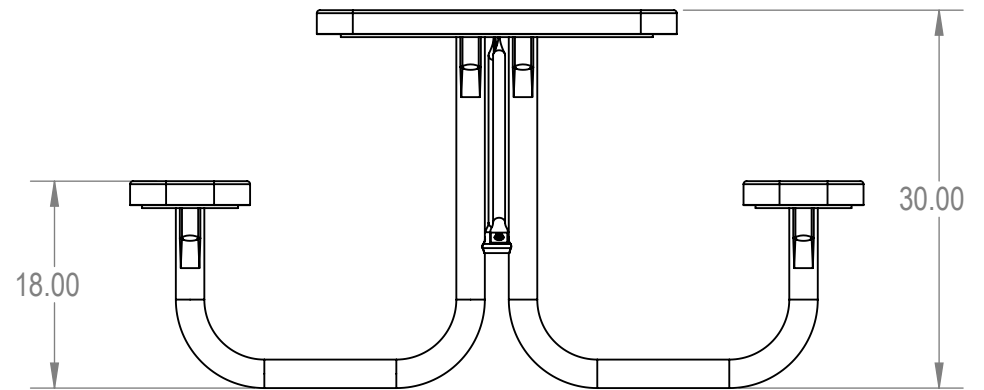

R3.00

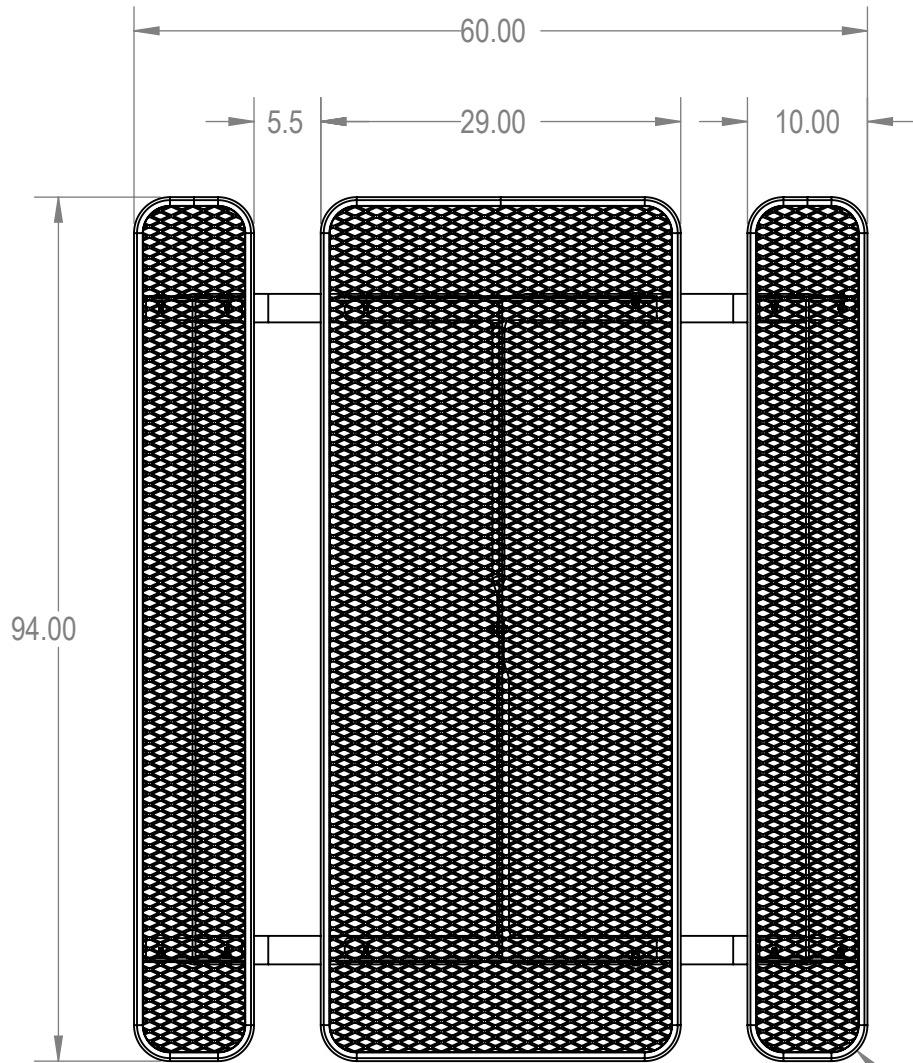

Mfg. by Advantage Panels & Fence, Inc.

MYTCOAT

Commercial Outdoor Furniture

www.mytcoat.com

PROPRIETARY AND CONFIDENTIAL

THE INFORMATION CONTAINED IN THIS DRAWING IS THE SOLE PROPERTY OF Advantage Panels & Fence, Inc. PO Box 1790 Whitney, TX. ANY REPRODUCTION IN PART OR AS A WHOLE WITHOUT THE WRITTEN PERMISSION OF Advantage Panels & Fence, Inc. PO Box 1790 Whitney, TX. IS PROHIBITED.

	NAME	DATE
DRAWN	GM	1/3/2016
SALES APPR.		
CLIENT APPR.		
MFG APPR.		
Q.A.		

Design By -

CADWorksPro
Chicago, IL

www.cadworkspro.com

AAdvantage Panels & Fence, Inc.

TITLE:

8' Rectangular Portable Table

Expanded Metal